

### Palatal Expander for TAD's

<b>201A0620-08</b>	8 mm	12 mm
<b>201A0620-10</b>	10 mm	15 mm
<b>201A0620-12</b>	12 mm	17 mm

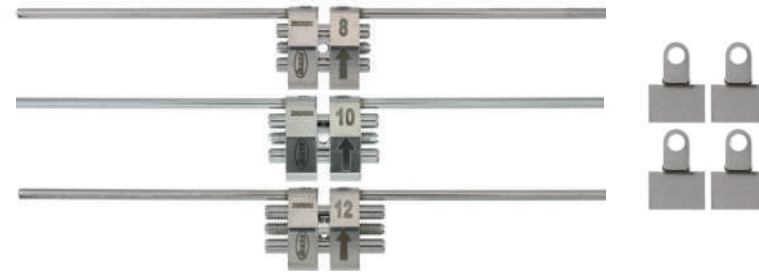

### CAD-CAM Anatomical Expander

<b>A0630-08D</b>	8 mm	12 mm
<b>A0630-10D</b>	10 mm	14 mm
<b>A0630-12D</b>	12 mm	16 mm



### CAD-CAM Rapid Expander tooth borne

<b>A0620D08</b>	8 mm	12 mm
<b>A0620D09</b>	9 mm	14 mm
<b>A0620D11</b>	11 mm	16 mm
<b>A0620D13</b>	13 mm	18 mm

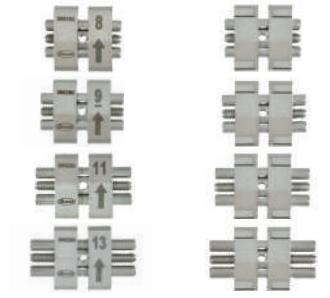

### CAD-CAM Stealth easy access tooth borne

<b>A1621-08D</b>	8 mm	12 mm
<b>A1621-11D</b>	11 mm	16 mm
<b>A1621-13D</b>	13 mm	18 mm



### CAD-CAM Torko Expander for lower tooth borne

<b>A0623-08D</b>	8 mm	12 mm
<b>A0623-11D</b>	11 mm	16 mm

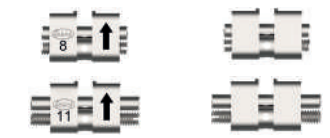

### CAD-CAM Leaf Expander tooth borne

<b>A2703-06D</b> 2 springs 450 g	6 mm	12 mm
<b>A2704-06D</b> 2 springs 900 g	6 mm	12 mm
<b>A2703-09D</b> 3 springs 450 g	9 mm	16 mm
<b>A2704-09D</b> 3 springs 900 g	9 mm	16 mm

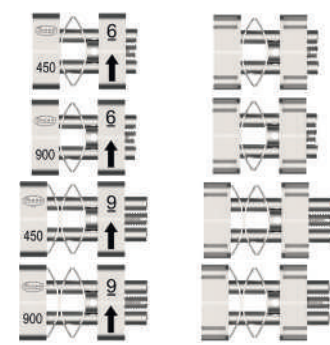

### CAD-CAM Leaf Self Expander tooth borne

<b>A2705-06D</b> 4 springs 450 g	6 mm	11 mm
<b>A2706-06D</b> 4 springs 900 g	6 mm	11 mm
<b>A2705-09D</b> 6 springs 450 g	9 mm	15 mm
<b>A2706-06D</b> 6 springs 900 g	9 mm	15 mm



**Leone** AMERICA

In orthodontics since 1934

TRADITION MEETS  
THE *FUTURE*

**Leone** AMERICA

LeoneAmerica  
Dental Products, Inc

805-487-9860  
info@leoneamerica.com  
www.leoneamerica.com

1641 South Rose Avenue  
Oxnard, CA 93033-2470

TRADITION MEETS  
THE *FUTURE*

Orthodontic Screws



IN-10-23

**Leone** AMERICA

### Expansion Screws

Leone expansion screws for removable orthodontic appliances are the result of 80 years of in-depth research, design studies and millions of clinical cases. The whole manufacturing process takes place in Italy with automated machines that work under the constant control of electronic processors. Leone screws are made of biomedical stainless steel of the highest quality. The thread of the male screw has centesimal tolerances. With total absence of surface roughness, the bodies and guides have precision tolerances of +/- 0.01 mm which ensures stability and absolute precision. The wide range available allows to create any type of removable device.

### Expanders and RPEs

Leone expanders are successfully used by most orthodontists worldwide. In particular, the 620 series is a high-quality product available in various sizes. Among the many particular features, the arms housed inside the expander body and laser-welded from the outside, ensures greater resistance and stability. The very high standards applied in every phase of the automated production and quality control, allow us to confidently state that we are offering the best RPEs and expanders in the world today.

### CAD CAM and 3DLeone Designer Expanders

Increasingly attentive to the rapid digital evolution of modern orthodontics, Leone developed synergistic solutions for our product range, enabling the dental technicians to work more safely and efficiently, saving time, and performing more.

That is why 3DLEONE DESIGNER was born; the first software based on a simple and fully digital guided workflow to digitally design customized frameworks made out for our innovative CAD-CAM RPEs.

The software is the result of the experience that Leone has acquired trying other available digital solutions. They all showed the need to develop a simple and intuitive dedicated software which would allow design, not only of bands and dental supports, but also of the automatic positioning for the RPE and the consequent creation of the arms, by using less time and reducing the possibility of human error.

The 3DLEONE DESIGNER software allows to import and manage stl files of the dental arches, whether these are generated by laboratory or intraoral scanners, and the library already includes the full range of Leone CAD-CAM expanders.

At the end of the guided design process, the software will export the stl file of the framework which, once sintered with the Laser-Melting process, will match perfectly with the chosen Leone CAD-CAM RPE, allowing a precise laser-welding.



**Leone** AMERICA

### Rapid Expander

<b>A0620-08</b>	8 mm	12 mm
<b>A0620-09</b>	9 mm	14 mm
<b>A0620-11</b>	11 mm	16 mm
<b>A0620-13</b>	13 mm	18 mm
<b>A0620-15</b>	15 mm	20 mm

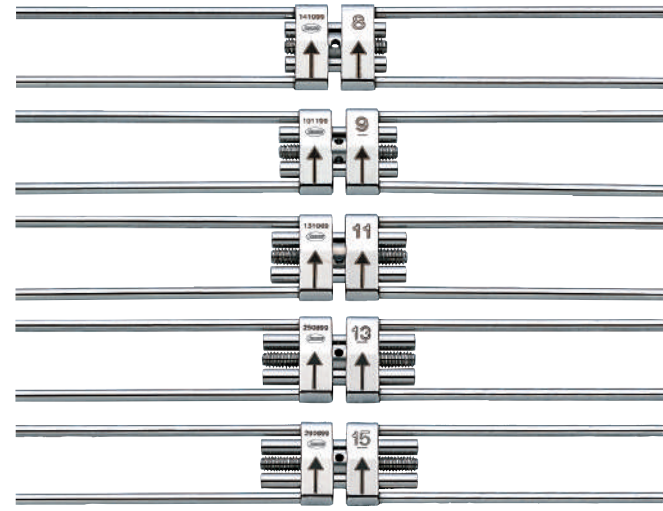

### Zoomrax Rapid Expander with telescopic guides

<b>A2620-07</b>	7 mm	11 mm
<b>A2620-10</b>	10 mm	14 mm
<b>A2620-12</b>	12 mm	16 mm

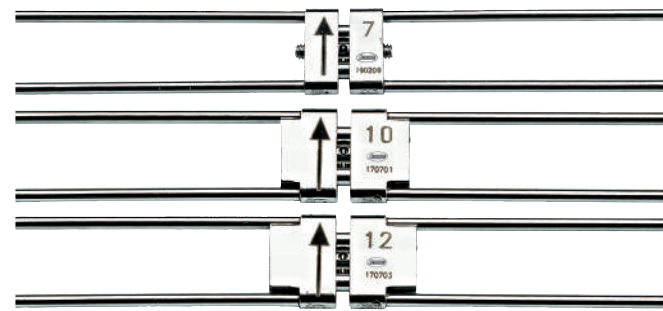

### Eagle Rapid Expander with orthogonal arms

<b>A0631-08</b>	8 mm	12 mm
<b>A0631-10</b>	10 mm	14 mm
<b>A0631-12</b>	12 mm	16 mm

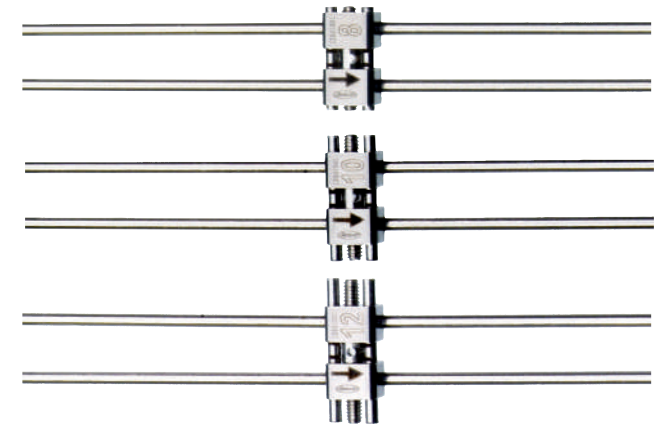

### Stealth Micro Expander for palatal suture

<b>A0621-08</b>	8 mm	12 mm
<b>A0621-11</b>	11 mm	16 mm



### Stealth Easy Access single arm micro expander

<b>A1621-08</b>	8 mm	12 mm
<b>A1621-11</b>	11 mm	16 mm
<b>A1621-13</b>	13 mm	18 mm

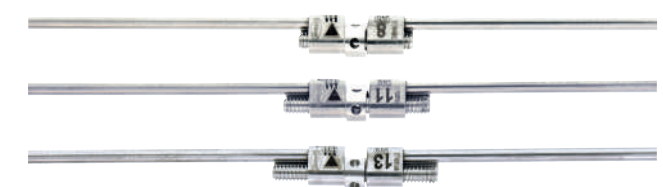

### Exspider Fan-type Rapid Expander

<b>A0625-09</b>	9 mm
<b>A0625-07</b>	7 mm

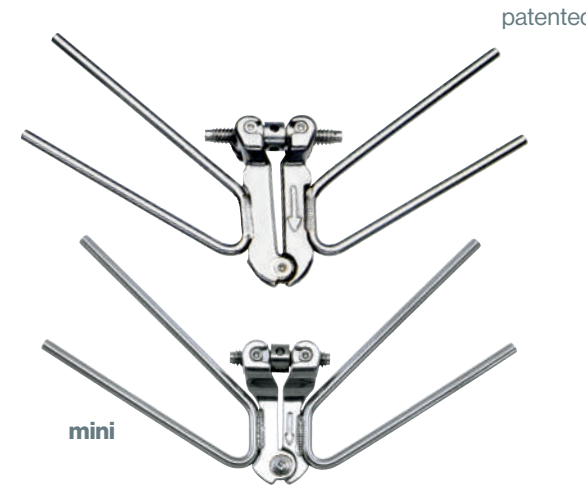

### Torko Expander for lower arch

<b>A0623-08</b>	8 mm	12 mm
<b>A0623-11</b>	11 mm	16 mm

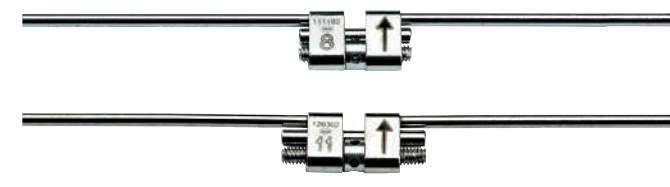

### Leaf Expander Series

<b>A2703-06</b> 2 springs 450 g	6 mm	12 mm
<b>A2704-06</b> 2 springs 900 g	6 mm	12 mm
<b>A2703-09</b> 3 springs 450 g	9 mm	16 mm
<b>A2704-09</b> 3 springs 900 g	9 mm	16 mm



### Leaf Self Expander

<b>A2705-06</b> 4 springs 450 g	6 mm	11 mm
<b>A2706-06</b> 4 springs 900 g	6 mm	11 mm
<b>A2705-09</b> 6 springs 450 g	9 mm	15 mm
<b>A2706-06</b> 6 springs 900 g	9 mm	15 mm

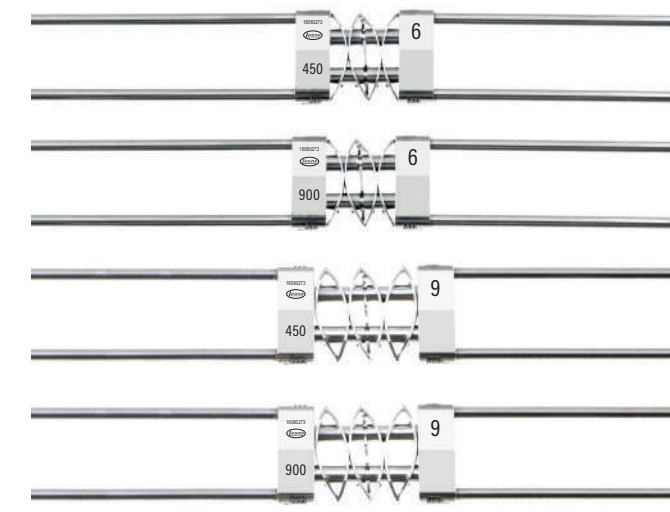

### POP screw for upper arch

- A4805-14G
- A4805-14E
- A4805-14R
- A4805-14V
- A4805-14T
- A4805-14A

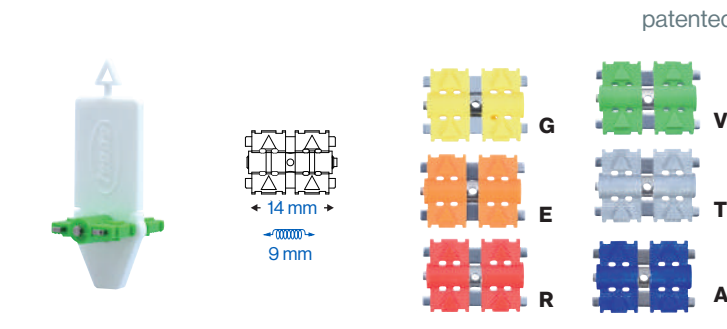

### POP screw universal

- A4800-12G
- A4800-12E
- A4800-12R
- A4800-12V
- A4800-12T
- A4800-12A

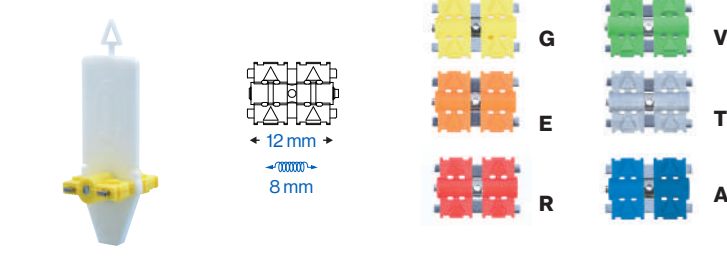

### POP Micro sectional screw

- A4801-00G
- A4801-00E
- A4801-00R
- A4801-00V
- A4801-00T
- A4801-00A

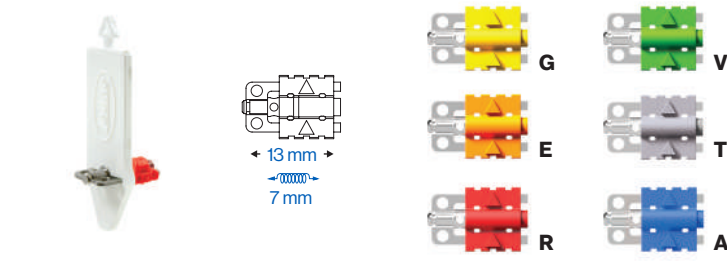

### Standard screw for upper appliances

- A0805-11
- A0805-14

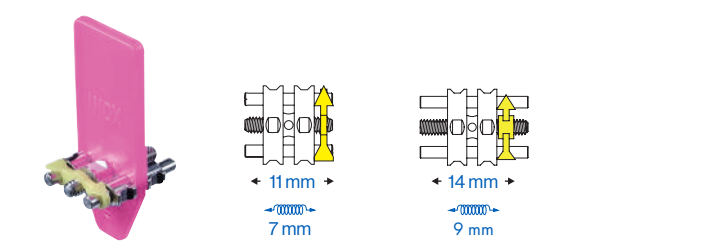

### Medium screw

- A0803-11
- A0803-14

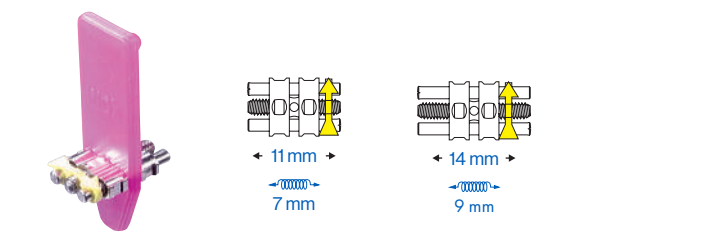

### Universal screw

- A0800-10
- A0800-12

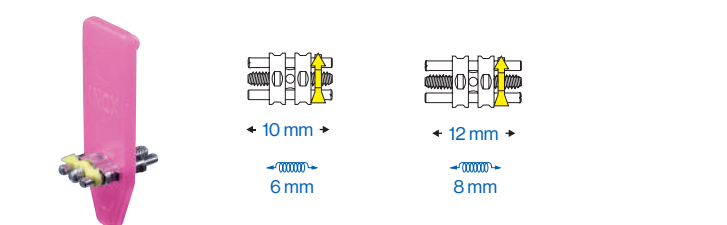

### Super micro screw

- A0890-11

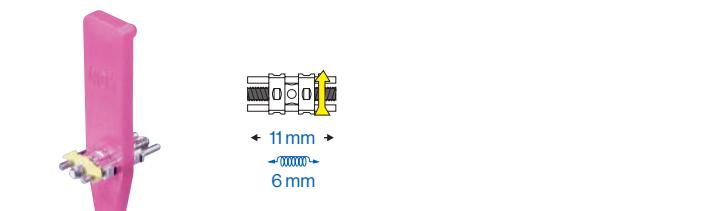

### Micro sectional screw

- A0801-10
- A0801-00

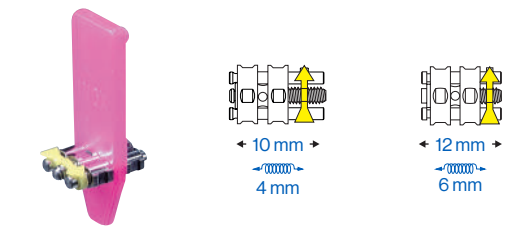

### Micro sectional screw with straight u-shaped guide pin

- A0801-12
- A0801-13
- A0801-14

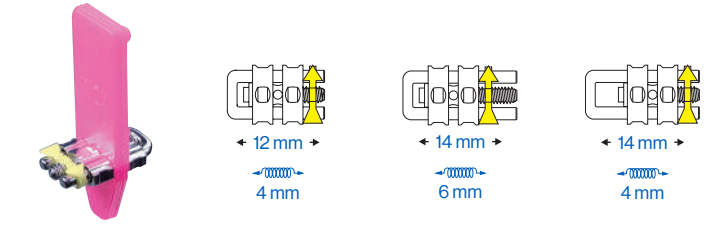

### Micro sectional screw with bent u-shaped guide pin

- A0802-00
- A0802-13

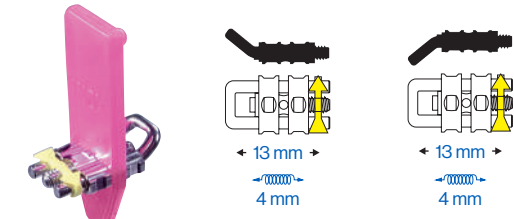

### Super micro sectional Screw

- A0891-09
- A0891-10

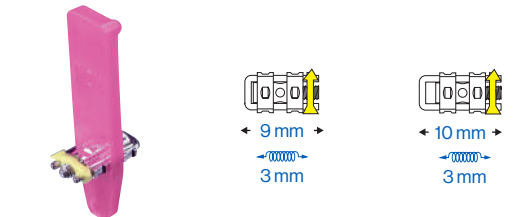

### Three directional screw anatomical

- A0930-14
- A0930-16

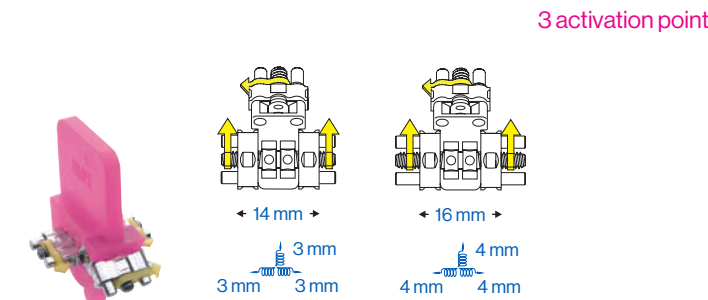

### Three directional screw anatomical

- A0931-14
- A0931-16

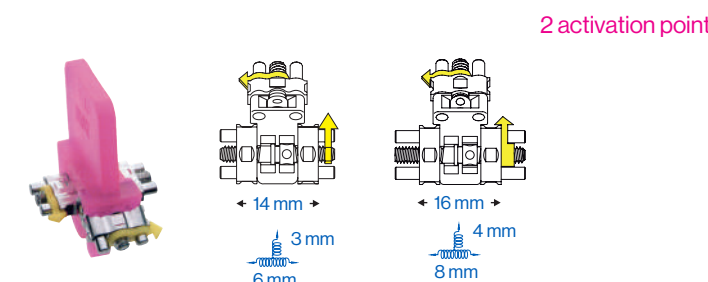

### Three directional screw anatomical for lower arch

- A0932-13

